

## SCIENTIFIC BASES OF PRODUCTION AND USE OF BIOFUEL IN AGROECOSYSTEMS

Golub G.<sup>1</sup>, Dubrovin V.<sup>2</sup>, Kukharets S.<sup>3</sup>, Marus O.<sup>4</sup>, Pavlenko M.<sup>5</sup>,  
Chuba V.<sup>6</sup>

*<sup>1</sup>Doctor of Sciences, Professor, National University of Life and Environmental Sciences of Ukraine, [gagolub@mail.ru](mailto:gagolub@mail.ru); <sup>2</sup>Doctor of Sciences, Professor, National University of Life and Environmental Sciences of Ukraine; <sup>3</sup> PhD, National University of Life and Environmental Sciences of Ukraine; <sup>4</sup> PhD, National University of Life and Environmental Sciences of Ukraine; <sup>5</sup> Assistant, National University of Life and Environmental Sciences of Ukraine; <sup>6</sup> Assistant, National University of Life and Environmental Sciences of Ukraine.*

### **Abstract**

The basic principles of biological and energetic conversions of organic raw materials in agro ecosystems with energy production and the opportunities ensure energy autonomy of agro ecosystems are set out. Also the opportunities to implement these principles in manufacturing of environmentally friendly production and biological diversity preserving have been analyzed.

**Key words:** biofuel, agro ecosystem, raw materials, energy production.

Introduction of biofuels – which are renewable resources of accumulated solar energy – into energy balance of Ukraine is one of today's urgent problems. This will enable to reduce the use of fossil non-renewable energy sources and environmental pollution with toxic substances and greenhouse gases.

Extension of biofuel use requires the balance between society's needs in food, raw materials, energy, and the opportunities of agroecosystems with parallel accumulation of solar energy in the form of humus, as well as maintenance and increase of biocenosis diversity.

The situation when the value of both industrially produced refined sunflower and rapeseed oil will be less than the price of diesel is hardly probable, because people's food needs (the recommended annual rate of oil consumption is 13 kg per person) are of primary importance when compared to energy use, therefore the profit from refined oil production will be greater than in the case of its realization as biodiesel (the rise in energy source prices is always accompanied by rising of food prices).

### **Introduction**

There is no doubt that every measure proposed for implementation in agroecosystems should not only provide soil fertility, but to favour the expanded

fertility renewal. Therefore, the important task is to determine the amount of plant biomass, which can be used in heating without any harm to soil fertility recovery.

It should also be taken into account that the use of technological processes with high mechanization level does not always lead to higher economic production indices because of increased deductions in production costs for technical servicing and repair of technical equipment, as well as deductions for depreciation, which are not compensated by additional production profits.

Oil-bearing crop production takes one of the leading positions in the structure of plant growing and in the whole system of agricultural production in Ukraine. In structure of total agricultural output, 35% of total production volumes in all farm categories are due to these crops. The main producers of these products manufacture 60% of oilseed products (Ostapchuk, 2011). In terms of food security, the volumes of domestic production fully satisfy domestic demands in these products, leaving some bulk for export and raw materials for biofuels.

### **Results and Discussion**

With due regard for well-known regularities and research results (Golub, 2010) it is developed the structural diagram and simulation model of diversified manufacturing of products with biological energy conversion of organic raw materials for 6-field crop rotation with a total area of 300 hectares (fig. 1).

Structural diagram of diversified manufacturing of agricultural products and energy envisages: growing of rotation field crops with production of grain and sugar beets; harvesting of crop straw and rape stalks; leaving of shredded corn stalks in the field as mulch; feed production for poultry; manufacturing of poultry products; methane (anaerobic) fermentation of poultry manure with production of heat and electric power from biogas; the preparation and use of grain crop straw and rape stalks for heating needs in the form of briquettes, rolls or chaff; usage of grain crop straw, rape stalks and fermented manure for compost production; production of substrate for champignon growing in compost and champignon production; production of biodiesel from rape seeds; use of glycerine residue for heating needs or its anaerobic fermentation.

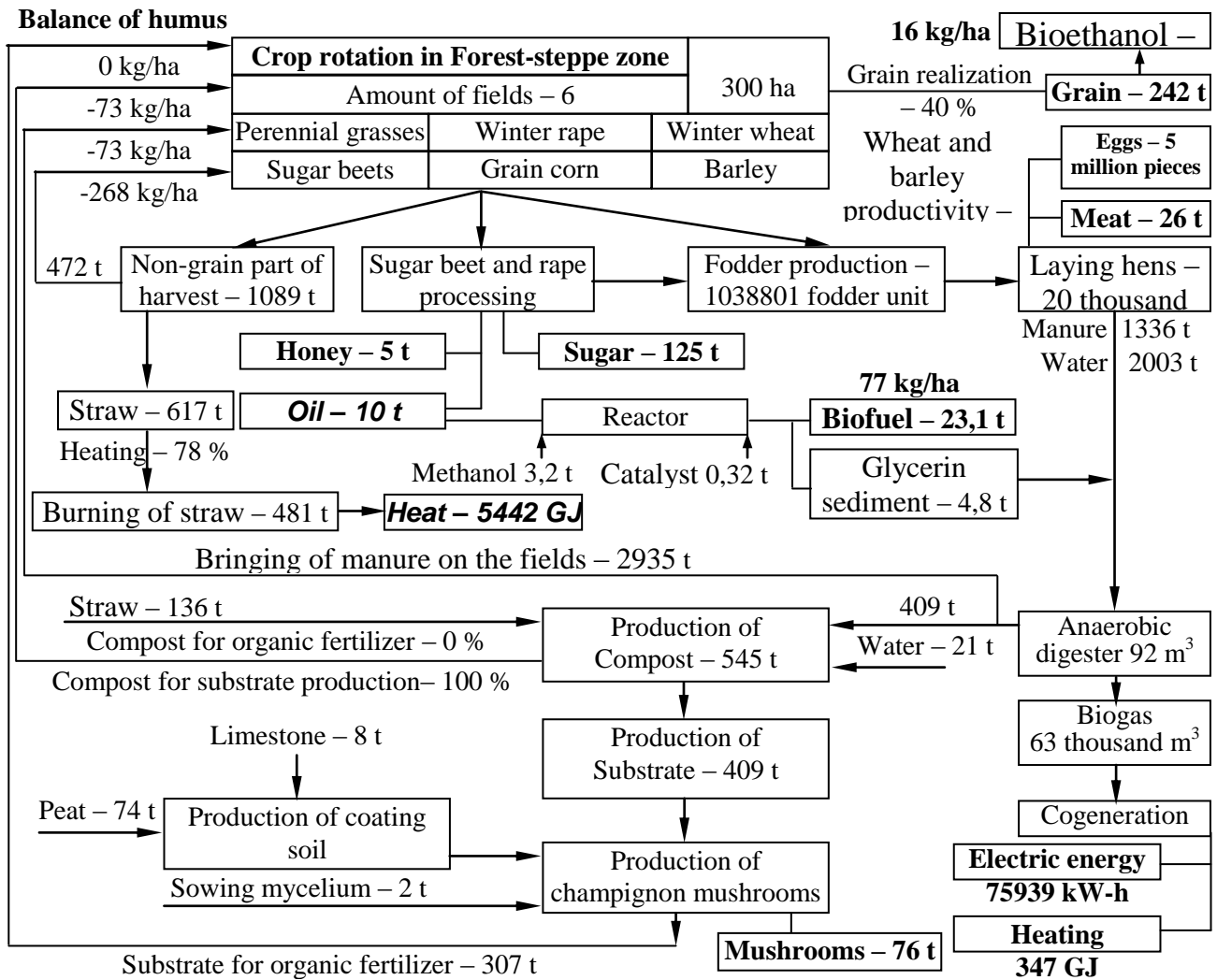

**Figure 1.** Structural diagram for manufacturing of production and energy on the basis of biofuels

On the basis of the introduced scheme it was defined the balance of humus in crop rotation using the well known equation:

$$B = \frac{1}{\sum_{i=1}^n S_i} \left[ - \sum_{i=1}^n S_i M_i + \sum_{i=1}^n S_i Y_i k_{CM_i} k_{\Gamma_i} + \sum_j^m OB_j \left( 1 - \frac{W_j}{100} \right) k_{\Gamma_j} \right], \quad (1)$$

where  $B$  – the annual balance of humus in crop rotation, kg/ha;  $S_i$  – the area under the  $i$  rotation crop, ha;  $M_i$  – mineralization of humus by the  $i$  rotation crop, kg/ha;  $Y_i$  – the productivity of the  $i$  rotation crop, kg/ha;  $k_{CM_i}$ ,  $k_{\Gamma_i}$  – output coefficients of dry weight of residues and their humification for the  $i$  rotation crop, rel. units.;  $OB_j$  – annual organic biomass volume of the  $j$  species (non-seed biomass

of agricultural crops remaining in the fields, manure, compost, substrate and biomass of weeds, green manure, etc.), which enters the field during a year, kg;  $W_j$  – relative humidity of organic biomass of the  $j$  species, %;  $k_{Tj}$  – humification coefficient of dry organic biomass of the  $j$  species, rel. units.;  $n, m$  – the number of rotation fields and the number of organic biomass species respectively, units.

The biggest influence on the balance of humus has grain crop capacity, as it in the biggest extant forms organic material revenues on fields and in lesser extent – the level of grain realization, as it affects the value of poultry fodder. Using all collected straw and rape stalks (losses are expected to be equal to 25%, including 10% of stubble and 15% of losses during harvesting, transportation and storage) for heating needs, the balance of humus in crop rotation can be approximated by the following linear equation of regression:

$$B = (-0,0537P + 33,123)Y - 975 \quad (2)$$

where  $P$  is the level of grain realization (of the total number of grown grain), % ;  $Y$  – the average wheat and barley capacity, kg/ha.

Computer simulation model allows determining the quotient of straw, which can be used for heating needs individually for separate farm. Thus, under the conditions shown in the figure, it can be reserved 78 % of straw for heating needs, and the part of the gathered straw in amount of 136 tons should be used for humus deficiency compensation in order to compensate humus losses completely. This can be done by two methods – either to leave some chopped straw in the fields or to develop on its basis compost or substrate for growing champignons.

On the basis of existing indicators, which characterize agricultural production in Ukraine while recent years in general, there were also made the calculations on defining the straw volume limits, used for heating needs (Golub, 2011). This dependence defined as a percentage of the total amount of straw is as follows:

$$C^{\%} = -0,57D + 48,66 \quad (3)$$

where  $C^{\%}$  is the straw amount limit from the total amount which can be used for heating needs, %;  $D$  – annual humus deficiency, kg/ha.

It should be mentioned, that in the case of the total humus deficiency in the range of 80 to 90 kg/ha, the use of straw for heating needs is impossible because of soil fertility preserving terms. The maximum amount of straw which can be used for heating needs with zero humus balance is about 50%.

To ensure use of corn and sunflower tops for heating needs, as well as of rape stems, there remain unsolved technical issues of this plant biomass storage, that's why nowadays it is usually crushed and left in the fields.

To ensure the process of straw burning, we have determined the heat of straw combustion. These calculations were performed by the empirical formula, which connects the lowest calorific value  $Q_h^p$  in kilojoules per kilogram of solid fuel and its elemental composition:

$$Q_h^p = 339C^p + 1030H^p - 109(O^p - S^p) - 25W^p \quad (4)$$

where  $C^p$ ,  $H^p$ ,  $O^p$ ,  $S^p$ , and  $W^p$  are mass fractions of carbon, hydrogen, oxygen, sulphur and moisture in the working mass of fuel, %.

When summarizing the data of chemical composition of straw it was assumed that the nitrogen-sulphur ratio in cereal straw is 5 units (in legume straw – 10 units), and the hydrogen-sulphur ratio is 56 units, which correspond to the averaged data according to (Barotfi and Rafai, 1988). The carbon-nitrogen ratio was taken as medium in volume, according to the data in (Skarda, 1985). On the basis of the generalized data, introduced in table 1 (Golub et al. 2009), there were received empirical calculation dependences for determination of heat of different types of straw combustion. These dependencies can be used in feasibility study of certain straw combustion efficiency. While calculations performed to prove the use of plant biomass for specific region or whole country, the heat of straw combustion should be determined by the equation, which takes into account the importance of the volumes of a particular straw type. For example, it is known that the main volumes of grain crop straw in Ukraine are presented by wheat straw (from 40 to 60%), barley straw (from 20 to 30%), rye straw (from 3 to 6%) and legume straw (from 2 to 8%). In recent years, it began to increase specific weight of rape straw, which reached values from 4 to 6%.

**Table 1.** Composition and calculation of straw combustion heat

Field crop – the straw producer	Content of dry weight, %								Calculation formula, MJ/kg
	Ash	Organic matter	Nitrogen, N	Carbon, C	Hydrogen, H	Oxygen, O	Sulphur, S	C/N	
Wheat	4,65	95,35	0,52	44,43	5,86	44,43	0,11	85	$Q_H^p = 16,261 - 0,1876W$
Rye	4,65	95,35	0,43	45,02	4,80	45,02	0,09	105	$Q_H^p = 15,309 - 0,1781W$
Barley	4,65	95,35	0,59	44,03	6,58	44,03	0,12	75	$Q_H^p = 16,914 - 0,1941W$
Oats	6,98	93,02	0,51	43,35	5,71	43,35	0,10	85	$Q_H^p = 15,865 - 0,1836W$
Corn	4,65	95,35	0,63	43,80	7,01	43,80	0,13	70	$Q_H^p = 17,304 - 0,1980W$
Rape	5,88	94,12	0,66	42,96	7,40	42,96	0,13	65	$Q_H^p = 17,520 - 0,2002W$
Grain legumes	6,98	93,02	1,64	41,02	9,19	41,02	0,16	25	$Q_H^p = 18,915 - 0,2141W$

With regard to the weight of straw yield above-mentioned crops, the lowest heat of its combustion  $Q_H^p$ , should be determined by the equation:

$$Q_H^p = 16,544 - 0,19W \quad (5)$$

where  $Q_H^p$  is the average lowest heat of straw combustion, MJ/kg.  $W$  is straw humidity, %.

It is well-known that grain crops, vegetative mass major producers, traditionally occupy from 40 to 55% in the structure of sowed crops. It should also be mentioned that with livestock decrease straw consumption for feeding and litter decreased as well, and the surplus straw is usually burned in fields (fig. 2).

Using straw in existing volumes would allow natural gas saving in the range from 4.5 to 14.3 billion m<sup>3</sup>.

It is necessary to mention the appropriateness and availability of rolled straw storage, because this technology allows quick removal of straw from fields and is realized by means of simple and reliable technical equipment.

According to our estimations, while annual volume of straw combustion at the rate of 30 million tons, the total amount of natural gas yielded will be 10.9 billion m<sup>3</sup>.

In these conditions, additional investments for preparation and combustion of straw will be 14.6 billion UAH, and their payback period will be from 1.2 to 1.3 years.

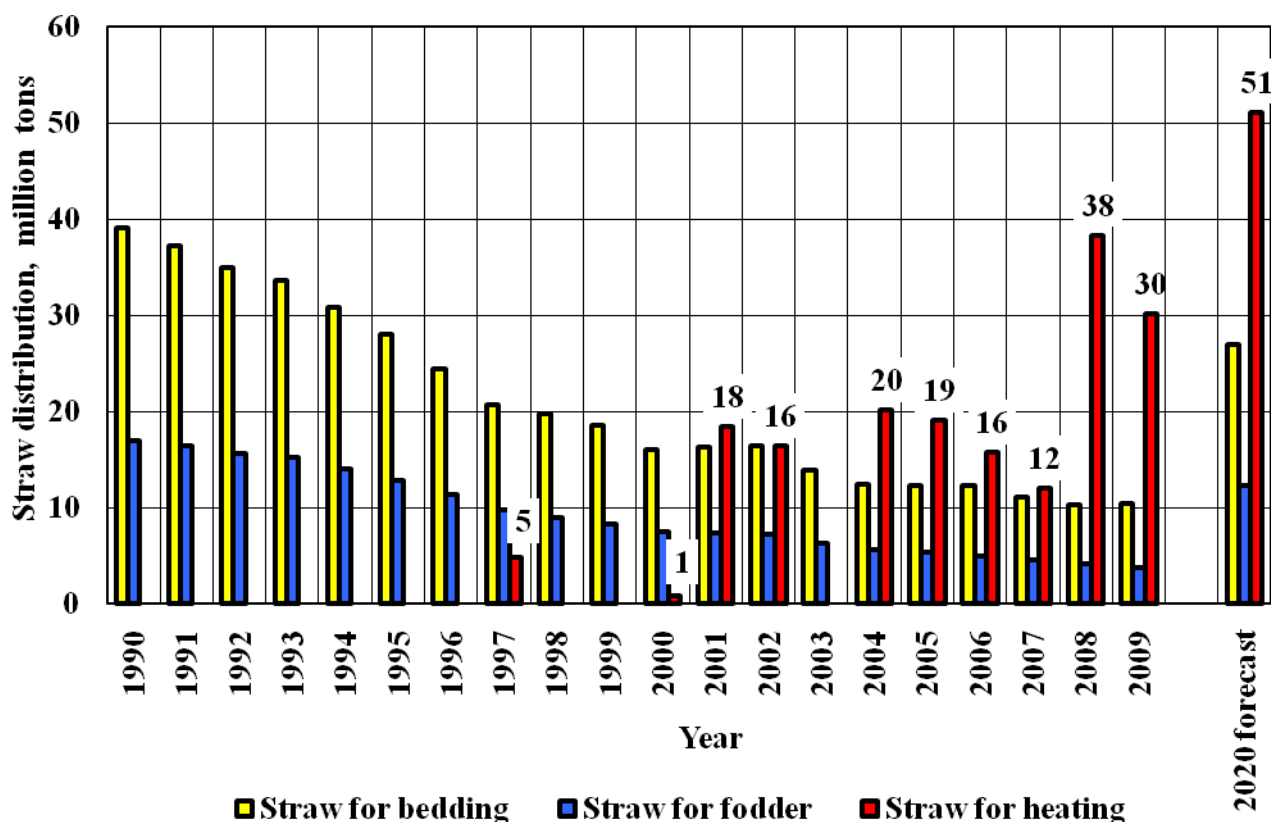

**Figure 2.** Straw distribution according to usage by years

Along with the direct combustion of plant biomass and of various fuels based on it, the most promising method of utilization is either the process of thermal processing of solid fuel without access for air or pyrolysis with obtaining solid residue (carbon), part of the liquid fraction (bio-oil) and pyrolysis gas with the combustion heat from 5 to 12 MJ/m<sup>3</sup> (Zhelyezna and Geletukha, 2005).

Use of sunflower husk, rape, buckwheat, rice, plant residues from the processing of cereals and other types of biomass as fuel demands increasing their energy density. For this purpose, sealing in compact briquettes is commonly used.

Among the various types of presses (screw, hydraulic, stamp) screw presses have simple design and relatively low cost. However, the design of screw press for briquetting of plant biomass into fuel briquettes is built with a single-sided support of the compressing work tool (screw). This leads to rapid wearing out of a work

member, forming device (matrix) and appearing of interterm backspacing of the sealant, resulting in reduced press productivity.

The calculations of straw combustion effectiveness on the basis of comparison to heat generation by natural gas burning have established the dependence of heat production efficiency on straw when compared to gas heating in terms of changing of straw cost (fig. 3).

We have upgraded screw briquetting press (fig. 4) for fuel briquette production (Golub et al. 2011). Screw press testing while production of fuel briquettes from sunflower husk and rapeseed with 8-14% moisture content crushed to 1-4 mm particles confirmed the functionality of the press.

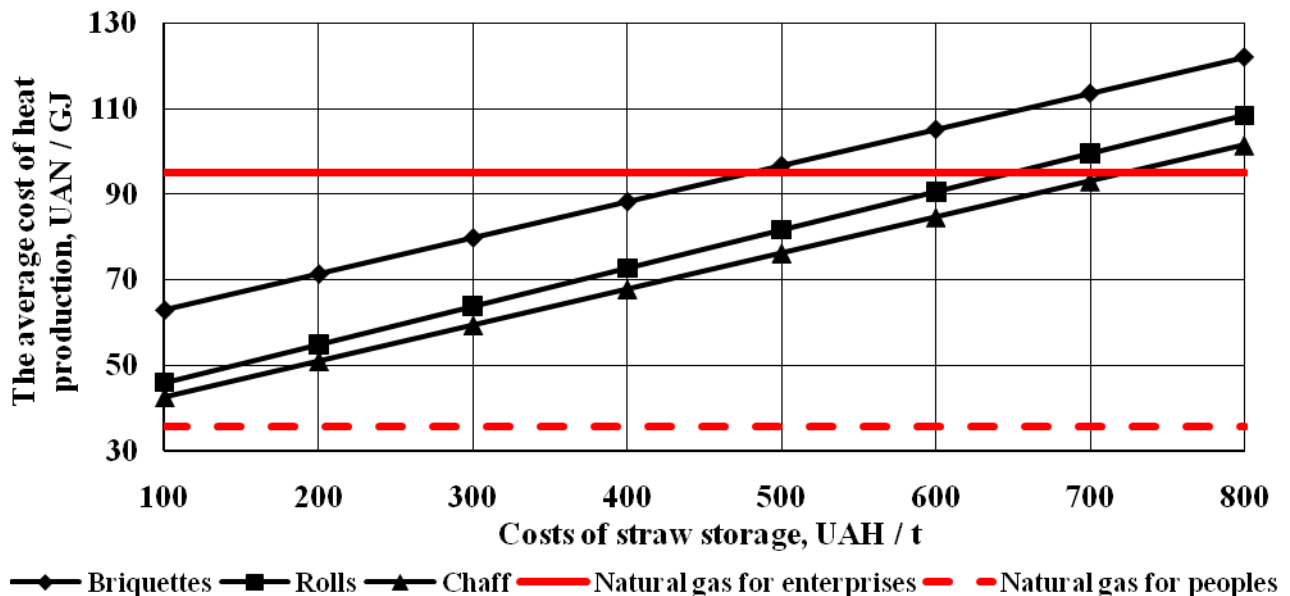

**Figure 3.** Efficiency of heat production from straw compared to gas heating by changing of straw value

As a result of production testing the following characteristics were identified: briquetting press productivity– 195-380 kg/hr.; power-intensity of the fuel briquette production– 62-129 kWh/h; fuel briquette density– 650-950 kg/m<sup>3</sup>.

While combustion of 20 kg of straw briquettes with density of 500 kg/m<sup>3</sup> complete combustion occurs for 46-47 minutes which is 3.9-4.6 times longer than chaff combustion time, and 2.6-3.2 times longer than the one of compressed straw bale (Kuzmich et al. 2000).



Using fuel briquettes contributes to complete combustion of volatile compounds emitted during combustion, reduce removal of heat and polluting components into environment.

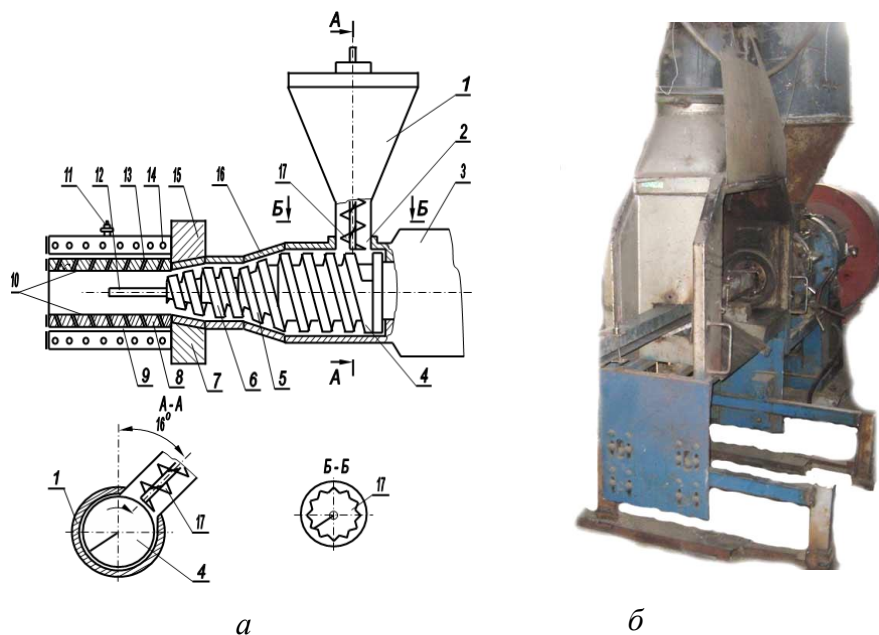

a – structural diagram of the press, b – general view of the press

**Figure 4.** Screw press for plant biomass briquetting

Similarly, it is determined that use of fuel briquettes in thermal processes instead of natural gas, saves 3.96 UAH at each cubic meter of natural gas combusted in heat boilers (heat generators) (natural gas price here is 4.7 UAN/m<sup>3</sup>).

We have evaluated different methods of oil mass cleaning. The analysis showed that one of the most effective ways of cleaning is settling. Considering that the rate of squeezed sunflower oil mass settling and sediment formation during sedimentation is proportional to the volume of sediment, we obtained kinetic equation of sedimentation, which has the following form (Golub and Pavlenko 2012):

$$\alpha = 0,82 [1 - \exp(-0,092k\tau)] \quad (6)$$

In graphic form kinetic equation is shown in fig. 5.

It is found that from the first to the third hour settling velocity is negligible. Later the motion rate of line between oil and sediment increases, after the second

day the formation of sediment slows down. During the third day it takes place the process of oil lighting.

In Ukraine there are many cases of usage by agricultural producers of rapeseed oil in mixture with diesel for diesel tractors which have exceeded their service life.

Analysis of the data shows that in the case of increase of oil press productivity from 100 kg / h. to 500 kg/h., working expenses of oil from soybeans will reduce 4 times, from rapeseed and sunflower – 3.5 times, and in the case of expansion up to 1000 kg/h. expenses will decrease 6 times, while from rapeseed and sunflower – 5.8 times. Agricultural enterprises usually use sunflower seeds for making food oil; rapeseed oil is not used as food, but it can be used to substitute biodiesel.

We found that rapeseed oil production for usage as biodiesel can be economically reasonable in terms of agricultural production, when compared to rapeseed selling if the total cost of production is high and close to the average selling price of rapeseeds, or if the price of realization is low and similar to the total cost of rapeseeds.

Using biodiesel to replace diesel, it is necessary to heat biodiesel in the fuel lines of low pressure up to the temperature which provides the determined level of biodiesel filtration. To increase efficiency and temperature range of biodiesel use, we have designed and made a two-stage heating system (fig. 6), which allows using biodiesel under any values of environment temperature and provides an increase in completeness of fuel combustion.

The second stage of fuel heating is made in the fuel pump-injector section for its better spraying and increase of speed and combustion completeness. The maximum temperature, up to which fuel heating can be made reaches 160°C and depends on structural characteristics of diesel engine and injectors (Anglin et al. 1961).

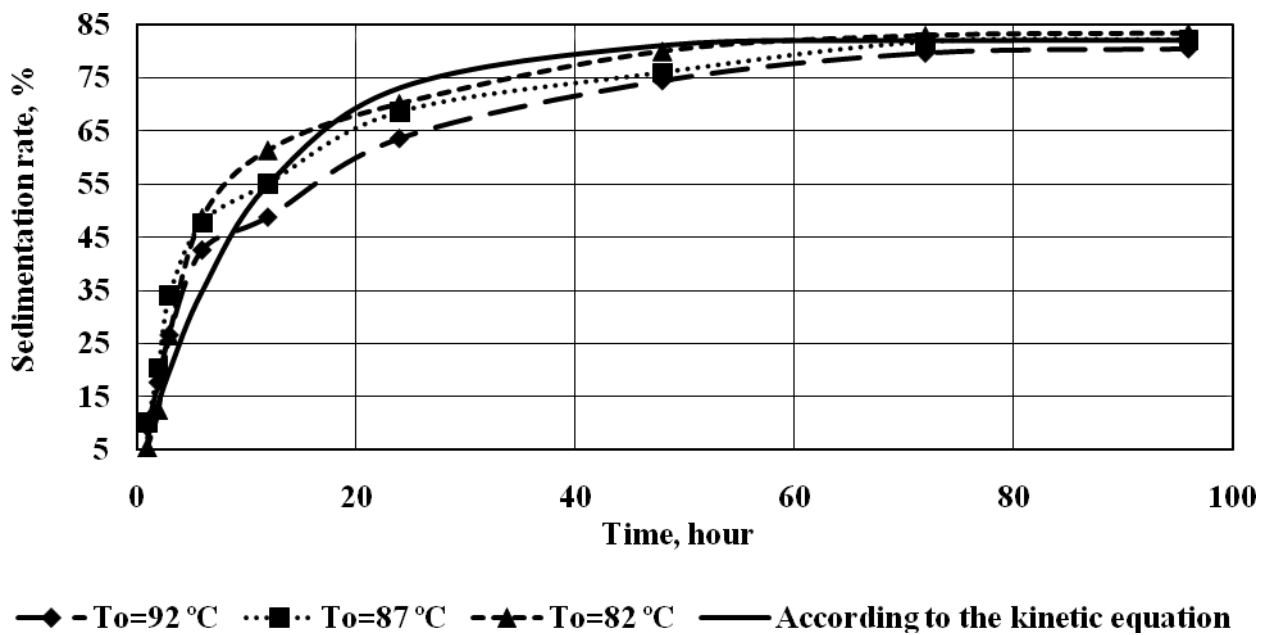

**Figure 5.** Kinetics of sedimentation of oil mass

Fuel prices are constantly increasing, and faster than those for agricultural products, which significantly affects production cost, realization price and farmers' profit. The analysis shows (fig. 7) that in 2000 farmers had to sell 4.5 tons of wheat to buy 1 ton of diesel, in 2006 it was necessary to sell 8 tons of wheat, in 2008 – 9 tons. Over the past 11 years the price of wheat increased 2.74 times and of diesel – 4.73 times.

On the basis of statistical data about consumption of diesel in agriculture and rape gross harvest, we have evaluated the capacity of replacing diesel to biodiesel while processing of whole rape harvest (fig. 8).

The largest consumption of diesel in agriculture for the observed period was observed in 2001, 2002, 2000, and the lowest – in 2006, 2007, 2008; in 2011 it was observed the tendency of diesel use increase when compared to 2010 from 1201.4 thousand tons to 1349.7 thousand tons. Rape gross yield increase is being observed since 2004, and in 2009 was observed production decline. The volume of biodiesel production while processing of the whole rape harvest was to be the highest for the investigated period in 2008 – 900.6 thousand tons of biodiesel, in 2009 – 587.3 thousand tons, in 2010 – 460.8 thousand tons, in 2011 – 387.9 thousand tons, and the lowest – in 2003 – 15.8 thousand tons, as well as in 2002 –

19.1 thousand tons. The quotient of diesel which can be substituted to biodiesel while processing of whole rape harvest was the largest in 2008 – 64.7%. At the same time, as it is predicted, production and use of biofuel in 2020 will not exceed 100 thousand tons per year (Geletukha and Zhelyezna 2012).

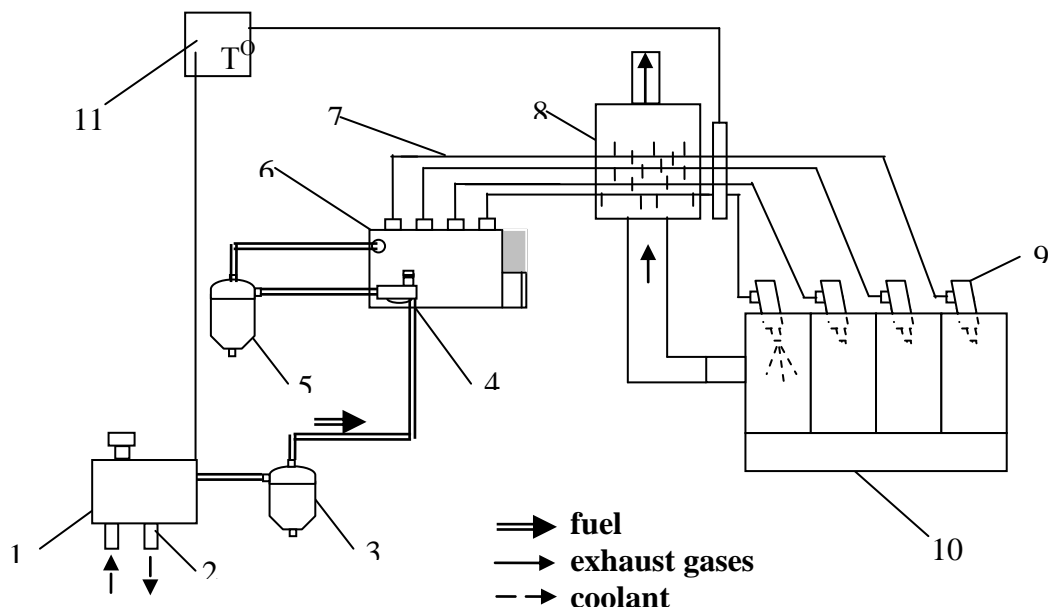

1 – fuel tank, 2 – heat exchanger, 3 – coarse filter, 4 – booster pump, 5 – fine filter, 6 – fuel channel of the high- pressure pump, 7 – fuel injection pipe, 8 – heating chamber, 9 –engine injectors 10 – engine 11 – temperature control unit

**Figure 6.** Scheme of the dual stage heating of biodiesel for motor and tractor engines

Farms can produce biodiesel after harvesting of oilseeds, i.e. in autumn. In autumn-winter period diesel is limitedly used in agricultural production –in animal husbandry only. The produced biodiesel is stored in warehouses for oil products till the beginning of spring field work. When stored in sealed containers, biodiesel does not lose its properties during the year, unlike rapeseeds and rape oil. Prices for fossil diesel are constantly increasing, especially at the beginning of spring, but the cost of produced biofuels in the previous year remained unchanged, that is one of the cost saving provisions in agriculture.

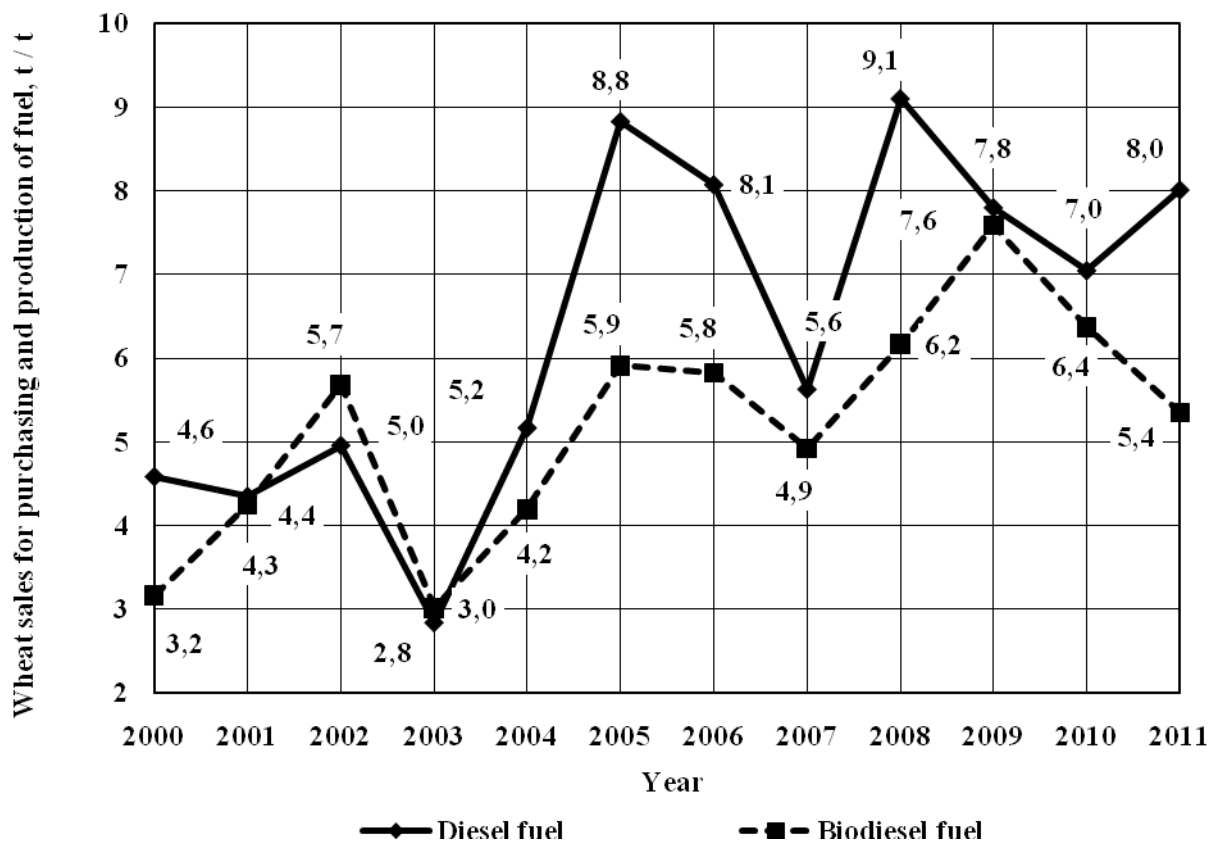

**Figure 7.** Change dynamics of required sale volumes of wheat to buy diesel or produce biodiesel

The profitability of production of rapeseeds, rapeseed oil and based on it biodiesel is affected by a number of factors including: the cost and selling price of rapeseeds, production capacity of equipment which was used for production of oil and biofuels, the price situation in the diesel market. Taking these factors into consideration, we have analyzed the indices for 2000-2010 (fig. 9). Profitability of rapeseed oil production was higher than the one of rapeseed production for the entire studied period, except of 2009 and 2010. Profitability of biodiesel production was lower than the one of oil and rapeseeds in 2000-2004, 2006, 2008, and 2009. Profitability of biodiesel production in 2005, 2007, and 2010 was greater than the one of rapeseed production, which can be explained by reducing of rapeseed realization cost (Golub and Lukyanets, 2013).

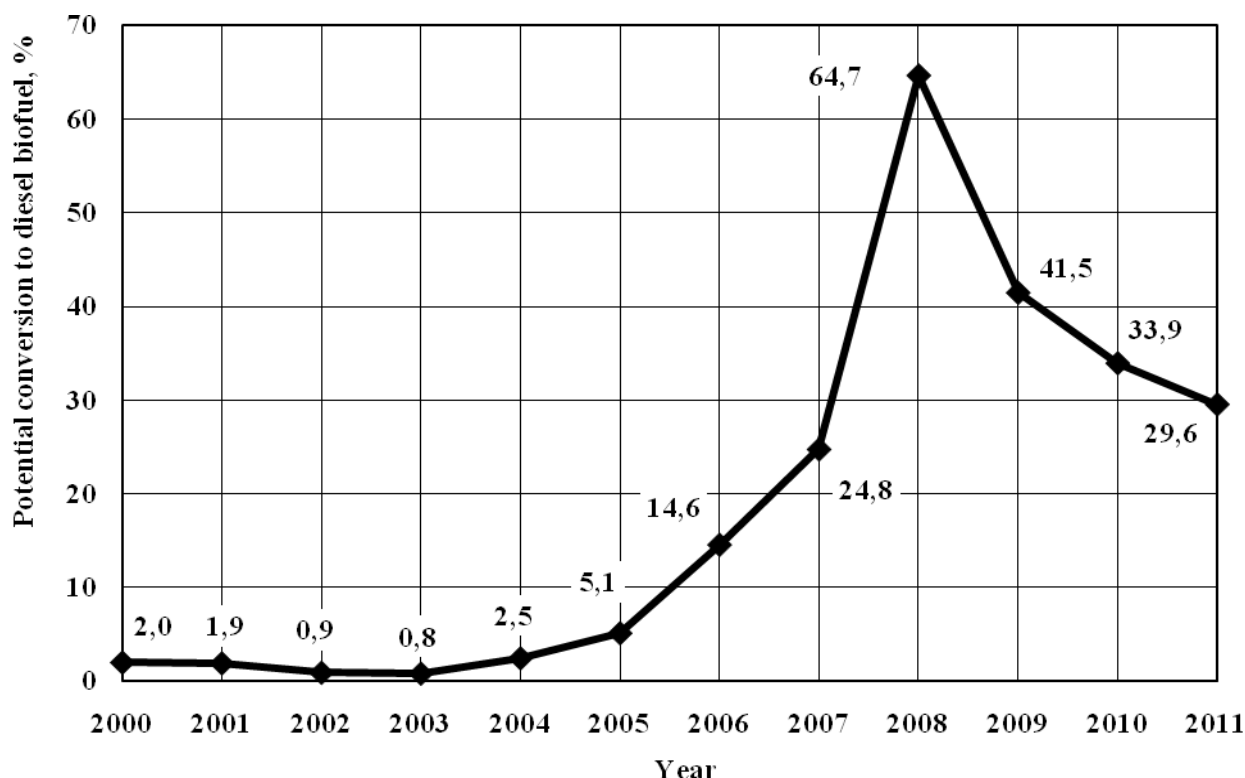

**Figure 8.** Change dynamics of potential transition to biodiesel while processing of whole rape harvest

Stable high demands, formed by the world market, and high prices provide highly profitable rapeseed production and are very attractive to investors. Profitability of rapeseed production was increasing till 2004 and reached 69%, and starting from 2005 up to 2007 it tended to decrease, and stabilized at 17-35%. Profitability of rapeseed oil production was increasing till 2004 and reached 81%, from 2005 to 2010 – it was decreasing (except in 2008, when there was the highest index – 86%) and stabilized at the level of 8-17%. Analyzing the profitability of biodiesel production, it should be mentioned, that by 2002 biodiesel production was not profitable, due to the relatively high cost of its production and a fairly low price for diesel. However, with the rising cost of fossil fuels, the profitability of biodiesel production has increased significantly, and from 2004 to 2007 exceeded even the profitability of crop production, confirming the effectiveness of investment and the need to develop the biofuel production branches.

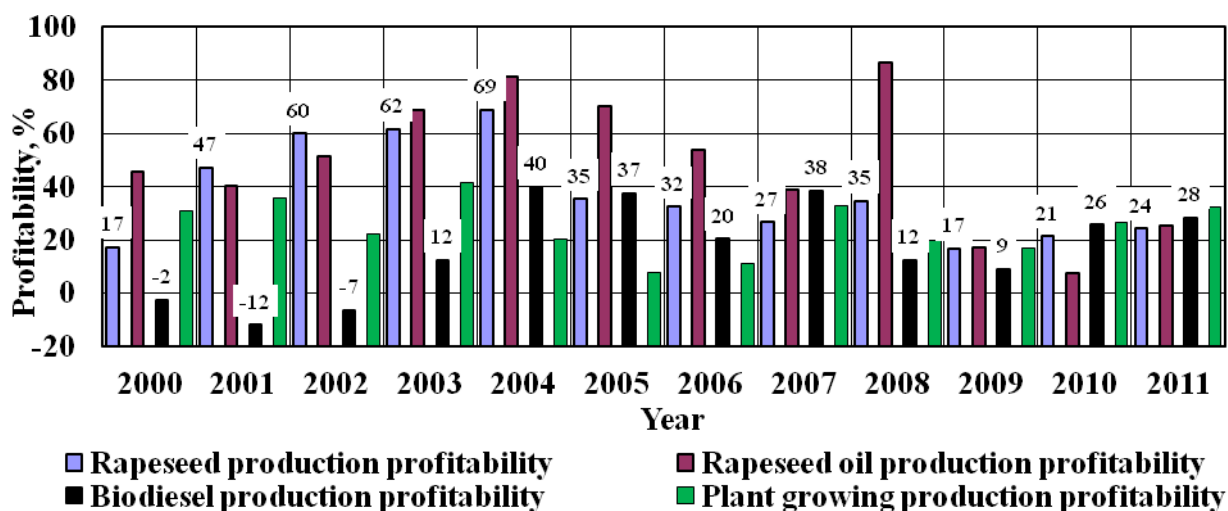

**Figure 9.** Indicators of profitability of crop production, rapeseeds, rapeseed oil and biodiesel on its basis

The analysis of interest rates on deposits of banks of Ukraine shows that for the 2000-2011 the interest rate for individuals ranged from 12.6 to 20.4%, for legal entities – from 6.6 to 13.8% (<http://www.bank.gov.ua>). However, investing money into biodiesel production, investor derives much greater profit. So, in 2004 the average interest rate on bank deposits for individuals was 15.7%, for entities – 8.9%, while the profitability of biofuel production was 39%, in 2007 respectively – 14.1 and 8.9%, and biofuel profitability – 37%, in 2010, rates of banks – 18.8% and 13.7%, while biofuel production – 24%. Raising funds to produce biodiesel, it is probable not only to improve the efficiency of invested capital, but also to make contribution into improving the environmental situation of the country, and into ensuring of power independence industry, as well as of the country as a whole.

## Conclusions

1. Biological and energetic conversion of organic agro enosis raw materials with energy production can ensure energy autonomy of agroecosystems in total energy balance. Though, it is impossible to do it according to the types of fuels and energy, since there is a limit on the possibility of autonomous production of electric power and gasoline. However, production of biodiesel and heat energy can be redundant. Source of raw materials that would meet the needs of agricultural

production under centralized bioethanol production is sufficient. At the same time, to implement such systems, first of all, it is needed to change the basic principles of society existence, regarding manufacturing of environmentally friendly production and biological diversity preserving.

2. The heat of straw combustion reduces down to 0.18 to 0.21 MJ/kg for each percent of its humidity increase. Energy efficiency is increased while burning straw in the compressed form (briquettes, pellets). Baled straw should be burned in boilers equipped with cameras for post-combustion of volatile compounds. Non-pressed straw should be burned in crushed form with use of eddy chambers.

3. Designed briquetting presses should be used in small and medium winnowing complexes with capacity from 10 to 50 t/h, with annual waste volume up to 600 tons/year and briquetting of plant material (straw, sunflower husks and non-fodder wastes) with humidity up to 14%.

4. Following the scientific-based structure of crop rotation, biofuel production can solve a number of problems and bring in returns to agricultural enterprise.

5. Oil mass has fully exfoliated during 4 days, allowing the following use of the received product for biodiesel manufacturing. It was found that temperature has no significant influence on sedimentation, while acid number together with content of moisture and volatile matters range in acceptable norms.

## **References**

1. Баротфи И., Рапан П. Энергосберегающие технологии и агрегаты на животноводческих фермах. Пер. С венг. Э. Шандора, А.И. Залепукина. – М.: Агропромиздат, 1988. – 228 с.
2. Голуб Г. А., Лук'янець В.О., Субота С.В. Гвинтовий прес для брикетування рослинної сировини: Патент на винахід 94007. Україна. МПК В30В11/24. – Заявка № а200909519; Заявлено 17.09.2009; Опубліковано 25.03.2011, Бюл. № 6. – 3 с.
3. Голуб Г.А. Енергетична автономність агросистем. – Вісник аграрної науки. – 2010. – № 3. – С. 50-54.



4. Голуб Г.А. Проблеми техніко-технологічного забезпечення енергетичної автономності агроєкосистем. – Збірник наукових праць Вінницького національного аграрного університету. Серія: Технічні науки. – Вінниця, 2011. – Вип. 7. – 140 с. – С. 59-66.
5. Голуб Г.А., Лук'янець В.О., Субота С.В. Теплота згоряння та умови спалювання соломи. – Науковий вісник Національного університету біоресурсів і природокористування України. – К., 2009. – Вип. 134. Частина 2. – 284 с. – С. 275-278.
6. Голуб Г.А., Лук'янець С.В. Інвестиційна привабливість виробництва і використання дизельного біопалива. – Економіка АПК. – 2013. – № 2. – С. 54-60.
7. Голуб Г.А., Павленко М.Ю. Кінетика процесу відстоювання віджатої олійної маси. – Науковий вісник Національного університету біоресурсів і природокористування України. Серія: Техніка та енергетика АПК / Редколегія: Д.О. Мельничук (відповідальний редактор) та інші – К., 2012. – Вип. 170, ч. 1. – 354 с. – С. 14-19.
8. Железная Т.А. Современные технологии получения жидкого топлива из биомассы быстрым пиролизом: обзор / Т.А. Железная, Г.Г. Гелетуха / Промышленная теплотехника. – 2005. – Т. 27. – № 5 – С. 79-90.
9. Кузьміч Я.А., Ткач В.В., Абрамов І.В., Концур В.В. Паливні брикети для потреб села// Механізація та електрифікація сільського господарства. Глеваха.– 2000. – Вип.83. – С. 159-163.
10. Место биоэнергетики в проекте обновленной энергетической стратегии Украины до 2030 года // Аналитическая записка – Гелетуха Г.Г., Железная Т.А – 18 октября 2012 года [Електронний ресурс]. – <http://www.qclub.org.ua/wp-content/uploads>.
11. Національний банк України [Електронний ресурс]. – <http://www.bank.gov.ua>.
12. Сільське господарство України. Стат. зб.; за ред. Ю.М. Остапчука. – К.: Державна служба статистики України, 2011. – 370 с.

13. Шкарада М. Производство и применение органических удобрений. Пер. с чешского З.К. Благовещенской. – М.: Агропромиздат, 1985. – 364 с.
14. Энглин Б. А., Откупщиков Г. П., Рубинштейн И. А. Влияние температуры и качества топлива на осмоление распылителей форсунок.// Химия и технология топлив и масел – 1961. – №3. – С. 55 – 60.